

# Polymatech<sup>®</sup>

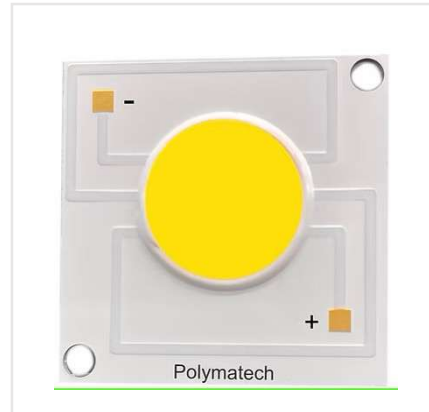

## DATA SHEET

### POLYMATECH STANDARD COB Series

Version 2

FL27COB3030 ALWAYS WHITE

**Retail Shop and Fashion Outlet Lighting**



**POLYMATECH ELECTRONICS LIMITED**  
[www.polymatech.in](http://www.polymatech.in)

# Polymatech Always White LED: Illuminate Fashion, Inspire Customers

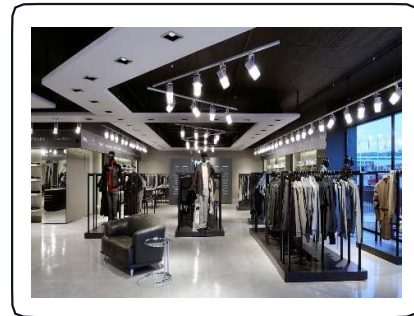
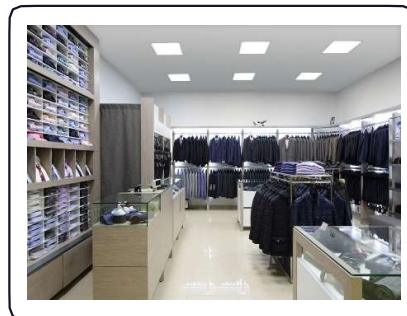
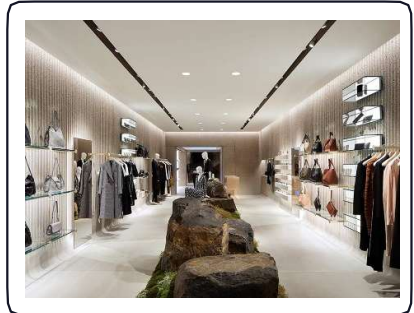

## Field of Use

### Polymatech Always White LED: Elevate Retail & Fashion Spaces

Polymatech's Always White LED solutions, engineered with CRI 80, are designed to provide premium, true-to-life illumination that enhances product colors, textures, and overall store ambiance. Retailers and fashion outlets increasingly rely on high-quality lighting to influence customer perception, highlight merchandise accurately, and create an inviting environment. In Polymatech's studies, Always White LEDs consistently outperform conventional commercial LEDs in rendering colors faithfully, boosting product appeal, and improving visual merchandising. Here's how Polymatech's technology delivers and why it stands out in the retail and fashion industry.



### True-to-Life Color Rendering

- **High CRI (80):** Polymatech Always White LEDs ensure products appear in their true colors, from clothing and fabrics to accessories and jewelry.

- **Accurate Visual Representation:** The LEDs highlight fine details, patterns, and textures, enhancing customer perception and encouraging purchase confidence.
- **Color Consistency Across Spaces:** Every corner of the store—from display shelves to racks and mannequins—receives uniform illumination, preventing color distortion.



### Tailored Lighting for Retail & Fashion

- **Balanced White Light:** Provides soft, glare-free illumination that creates a comfortable and premium shopping experience.
- **Accent Lighting Integration:** Compatible with spotlights and track lighting, enabling targeted illumination for featured products, promotional displays, and mannequins.
- **Visual Merchandising Optimization:** Polymatech LEDs ensure products are showcased in the best light, reinforcing brand identity and enhancing customer engagement.

### Innovative Integrated LED Modules

- **Uniform Illumination:** The integrated module design prevents uneven light distribution, harsh shadows, or hotspots, ensuring professional-grade lighting across the store.

- **Ambiance Creation:** Polymatech Always White LEDs contribute to a warm, inviting atmosphere, encouraging shoppers to explore and engage with merchandise.
- **Feature Highlighting:** Allows strategic highlighting of premium products or collections, enhancing their visual impact.



### Energy Efficiency & Long-Term Performance

- **High Luminous Efficacy:** Delivers bright, consistent light while minimizing energy consumption compared to traditional lighting solutions.
- **Extended Lifespan:** Designed for long operating hours typical in retail environments, reducing maintenance and replacement costs.
- **Eco-Friendly Operation:** Efficient LEDs reduce carbon footprint while maintaining premium lighting quality.

### Enhanced Customer Experience

- **True Product Colors:** Shoppers see merchandise in its actual color, reducing the risk of returns and enhancing satisfaction.
- **Inviting Store Environment:** The natural white light improves the overall aesthetics of the store, enhancing the perception of

quality and luxury.

- **Extended Shopping Time:** Comfortable and visually appealing lighting encourages customers to spend more time exploring products.



### Why Polymatech Outshines Competitors

- **Superior Color Accuracy:** Unlike many retail LEDs that distort colors, Polymatech Always White LEDs maintain CRI 80 across all brightness levels.
- **Consistent Light Distribution:** Avoids uneven lighting that can diminish product appeal, providing smooth illumination throughout the store.
- **Retail-Specific Optimization:** Engineered for merchandise presentation, accentuating textures and details that standard LEDs fail to highlight.
- **Integrated Lighting Solutions:** Combines ambient and accent lighting capabilities in one versatile product line, reducing the need for multiple lighting fixtures.

## Contents

1.	Introduction	P 8
2.	Performance Characteristics	P 10
3.	Mechanical Dimensions	P 11
4.	Characteristic Curves	P 12
5.	Reliability	P 15
6.	Packing Specification	P 17
7.	Precaution	P 18

## Product Nomenclature

---

### FL27COB3030 ALWAYSWHITE

---

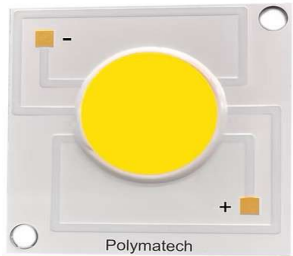

---

[1]	Product shape	: FL27COB3030
[2]	Die count in series	: 12
[3]	Die count in parallel	: 01
[4]	CRI (Ra)	: 80

---

## **INTRODUCTION**

### **Product Description**

The FL27COB3030 series of high-flux, multi-die arrays in a smaller, easy-to-use platform. With FL27COB3030 LED lighting-class reliability, the FL27COB3030's small, uniform emitting surface enables both directional and non-directional lighting applications including lamp retrofit and luminaire designs. featuring a 17-mm optical source, the FL27COB3030 brings new levels of flux and efficacy to this form factor.

The FL27COB3030 series is designed with flip chip technology which has high heat emission property thus increasing product life and maintaining same CRI output.

### **Applications**

- Apparel Display
- Jewellery & Accessories Highlighting
- Store Ambiance Enhancement
- Product Texture & Detail Visibility
- Visual Merchandising Support
- Consistent Lighting Across Store
- Accurate Color Perception

## Features

- Mechanical Dimensions : 30×30×1(mm)
- Packaging Structure : Aluminium Base Chip on Board
- Reference Assembly : M4 screw, Connector
- CRI(Ra) : 80
- Thermal Resistance : 2C/W
- Maximum Drive Current : 700mA
- RoHS Complaint.
- Better die arrangement for optics.
- Wide range of luminous flux and high efficacy.
- Improved lumen density compared with previous version.
- High Thermal conductivity package.
- Large, monolithic chips with uniform emitting area.
- Encapsulated die with low profile protective window for higher lumen output.
- Electricity isolated thermal path.
- Environmentally friendly: RoHS and REACH complaint.

## Performance Characteristics

(Tj=85C)

Product code	CRI	Luminous flux (lm)			Efficacy (lm/W)	Forward Current (mA)	Forward Voltage (V)		
		Tj85C		Tc25C*			Min.	Typ.	Max.
	Ra	Min.	Typ.	Max.	Typ.				
FL27COB3030 ALWAYS WHITE	80	396	450	489	148	700	20	20.5	31

Notes:

1. Polymatech Electronics maintains a tolerance of  $\pm 10\%$  on luminous flux measurements.
2. Polymatech Electronics maintains a tolerance of  $\pm 3\%$  on forward voltage measurements.
3. Polymatech Electronics maintains a tolerance of  $\pm 2\%$  on Ra measurements.

\*: Values of Luminous flux at Tc=25C are provided as reference only.

## Absolute Maximum Ratings

Parameter	Symbol	Rating	
Input Power	Pi	6.4	*1
Forward Current(mA)	If	700	*1
Reverse current(mA)	Ir	1	
Operating Temperature(C)	Top	-40 ~ +100	
Storage Temperature(C)	Tst	-40 ~ + 100	*2
Case Temperature(C)	Tc	105	
Junction Temperature(C)	Tj	125	*3

\*1. Input power and forward current are the values when the LED is used within the range of the derating curve in this data sheet.

\*2. Refer to 3. Outline drawing for Tc MEASUREMENT POINT.

\*3. Junction temperature calculation formula:  $T_j = T_c + R_{j-c} \times P_i$

## Mechanical Dimensions

The COB dimensions are 30 X 30 mm.

Tolerances Unless otherwise specified: +/-0.3

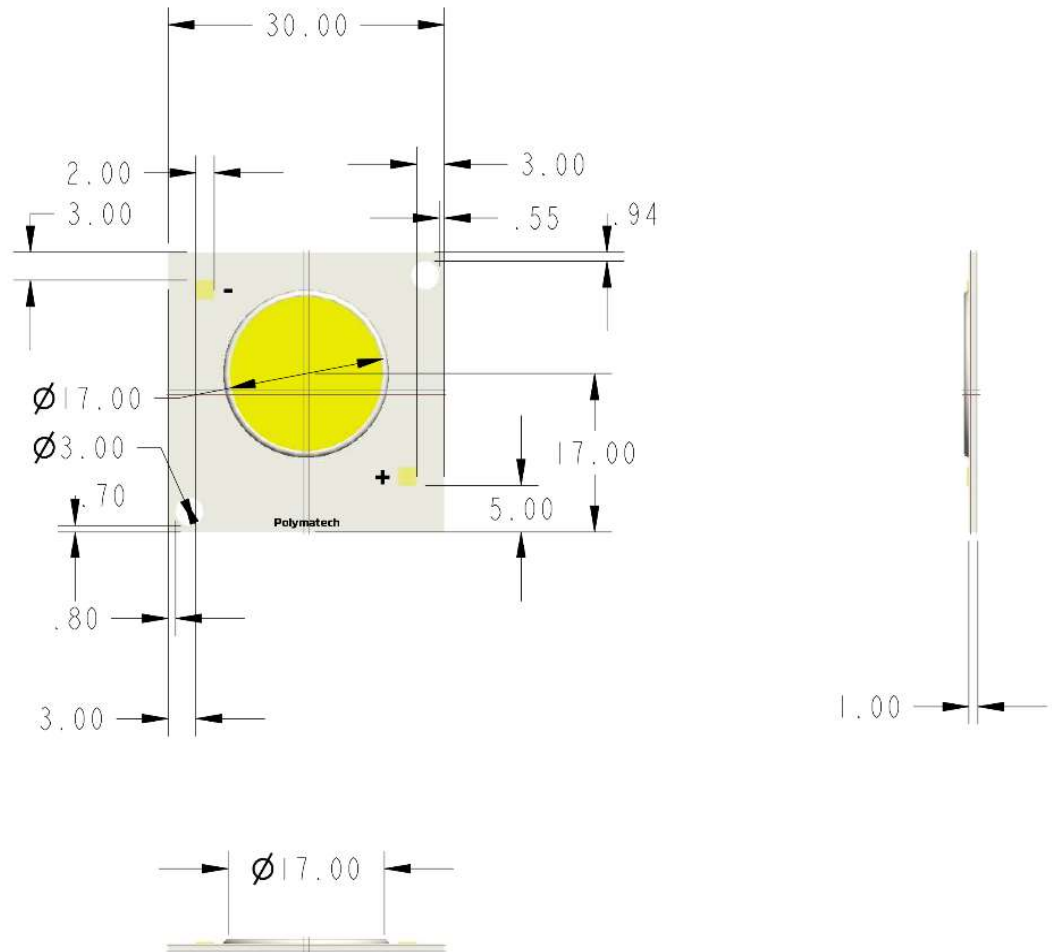

Dimensions are in mm.

Tolerances unless otherwise specified: +.13

$x^{\circ} +1$

# Characteristics Curves

## Forward Current Characteristic/Temperature Characteristics

Forward Current VS. Forward Voltage

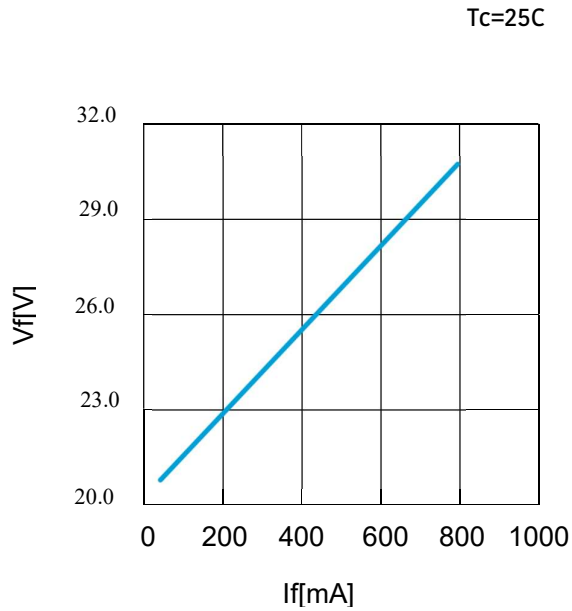

Case Temperature vs. Forward Voltage

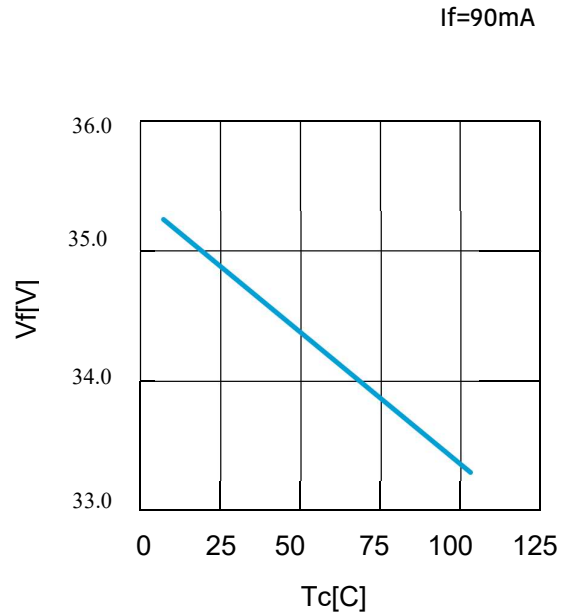

Forward Current VS. Relative Luminous Flux

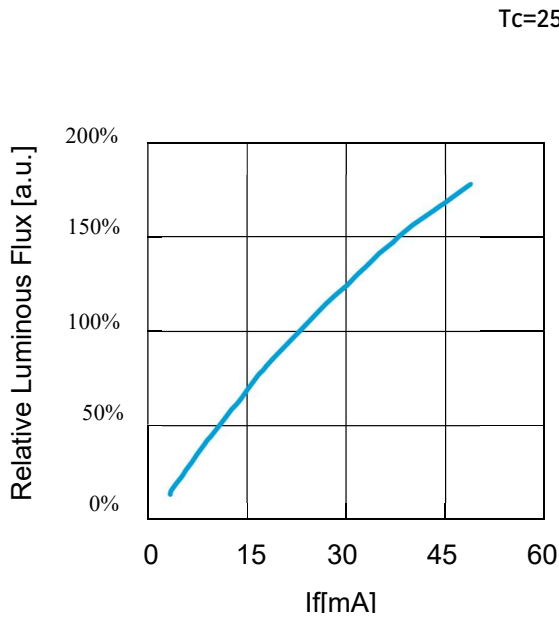

Case Temperature vs. Relative luminous flux

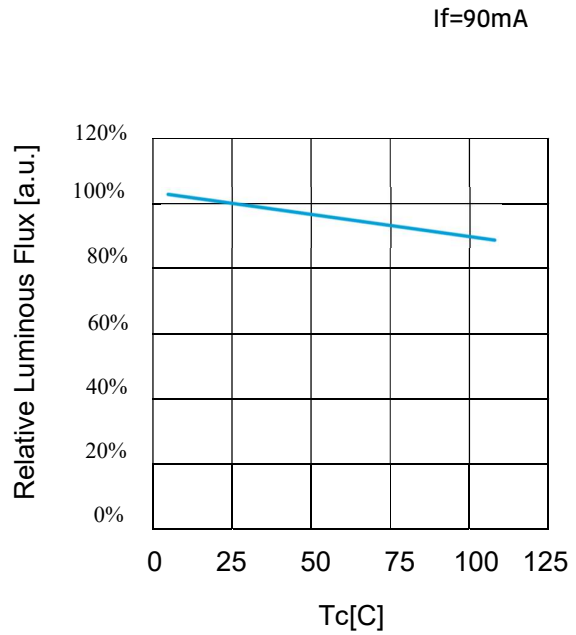

## Optical Characteristics

Spectrum: CRI(Ra) 80

Spectral Power Distribution

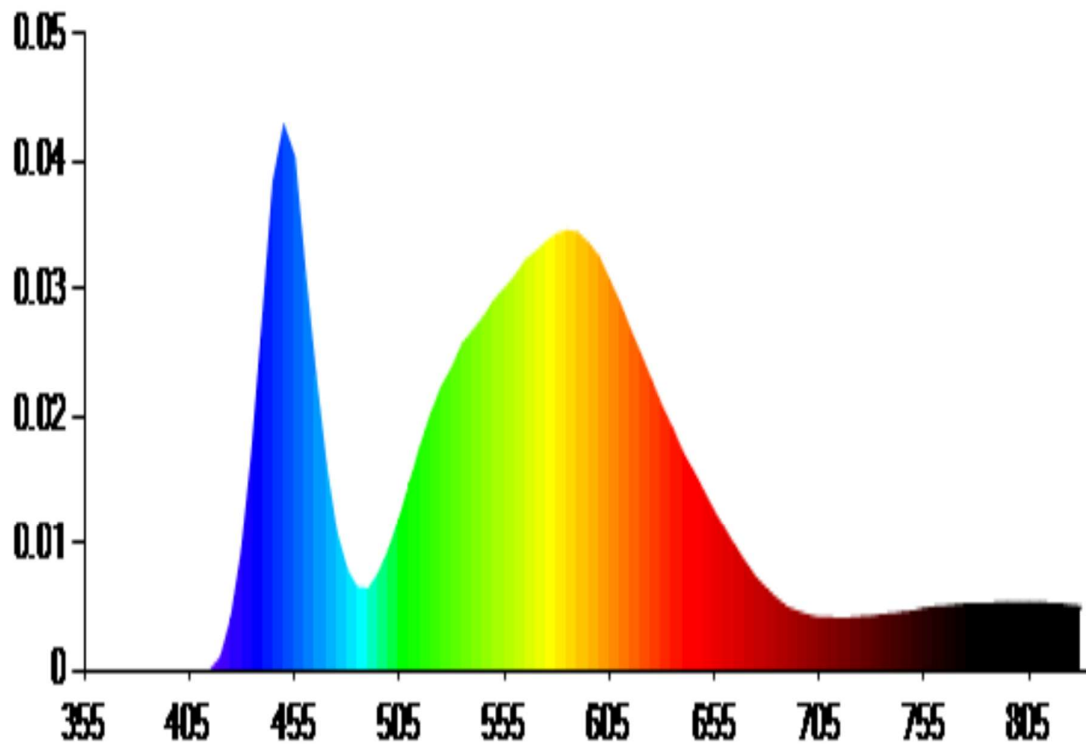

## Optical characteristics (continued) Radiation Characteristics

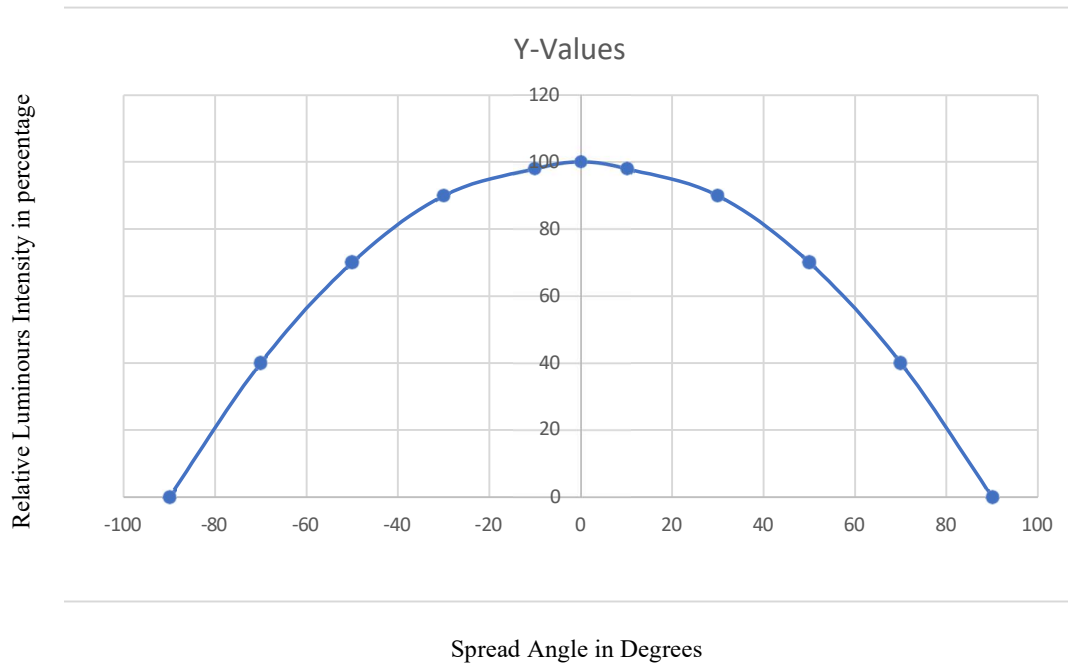

## Derating Characteristics

Case Temperature

vs. Allowable Forward Current

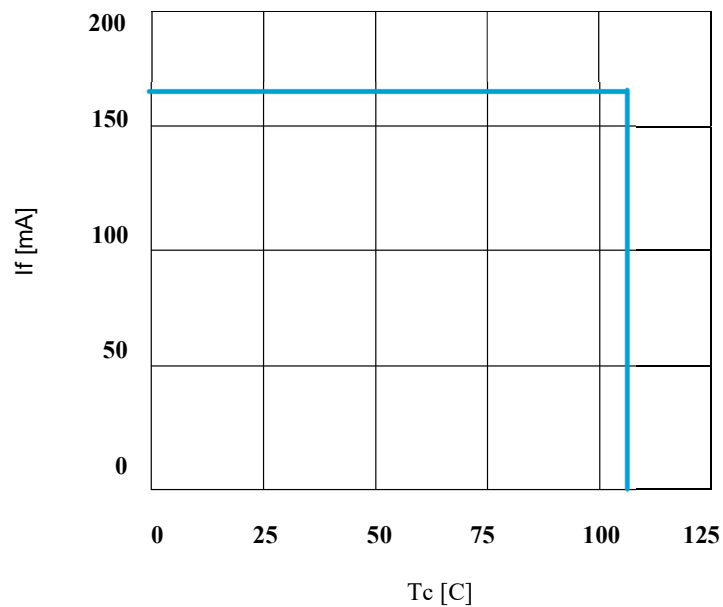

## Reliability

### Reliability Test

Test Item	Test Condition
Continuous Operation Test	If=90mA, Ta=25C (with A1-fin) × 1000 hours
	If=90mA, Tj=120C (with A1-fin) × 1000 hours
Low Temperature Storage Test	-40 C × 1000 hours
High Temperature Storage Test	100 C × 1000 hours
Moisture-proof Test	60C, 95%RH for 500 hours
Thermal Shock Test	-40 C × 30 minutes - 100 C × 30 minutes, 100 cycle

## Failure Criteria

(Tc=25C)

Measuring Item	Symbol	Measuring Condition	Failure Criteria
Forward Voltage	Vf	If=90mA	>U × 1.1
Total Luminous Flux	ΦV	If=90mA	<S × 0.85

U defines the upper limit of the specified characteristics. S defines the initial value.

Note: Measurement shall be taken between 2 hours and 24 hours, and the test pieces should be return to the normal ambient conditions after the completion of each test.

## Operating limits

The maximum current rating of the FL27COB3030 depends on the case temperature ( $T_c$ ) when the LED has reached thermal equilibrium under steady-state operation. The graphs shown below assume that the system design employs good thermal management (thermal interface material and heat sink) and may vary when poor thermal management is employed. Polymatech Electronics LED recommends a maximum Junction temperature of 135 °C to ensure optimal LED lifetime.

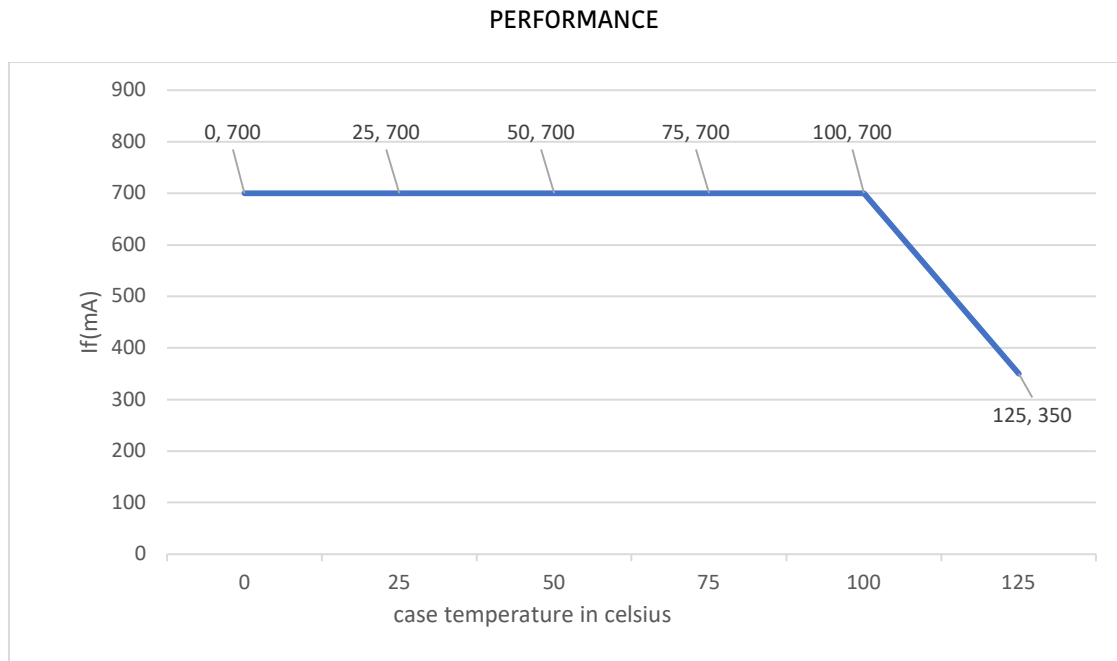

## Packaging Specification

### Packing

The package each tray contains 30 pieces of COBs and each box contains 12 trays of COBs (Vacuum Sealed).

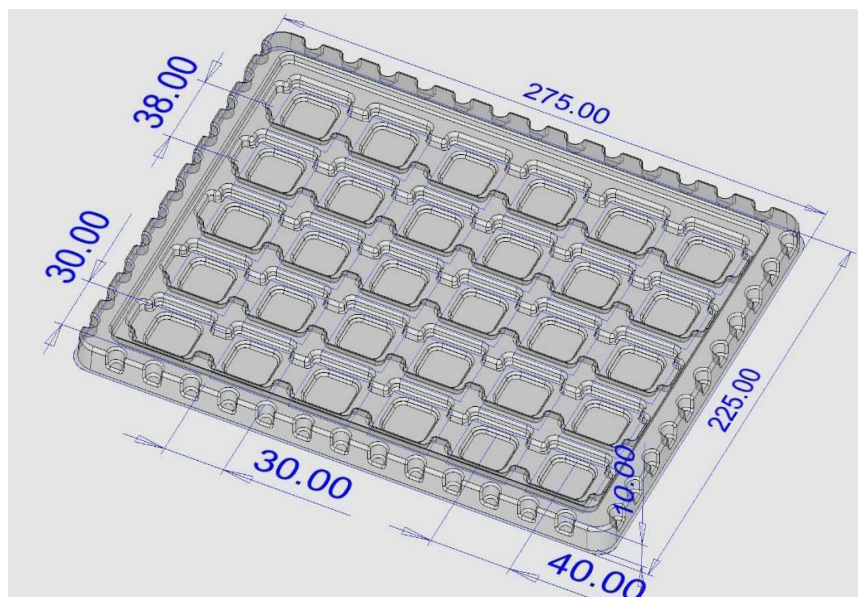
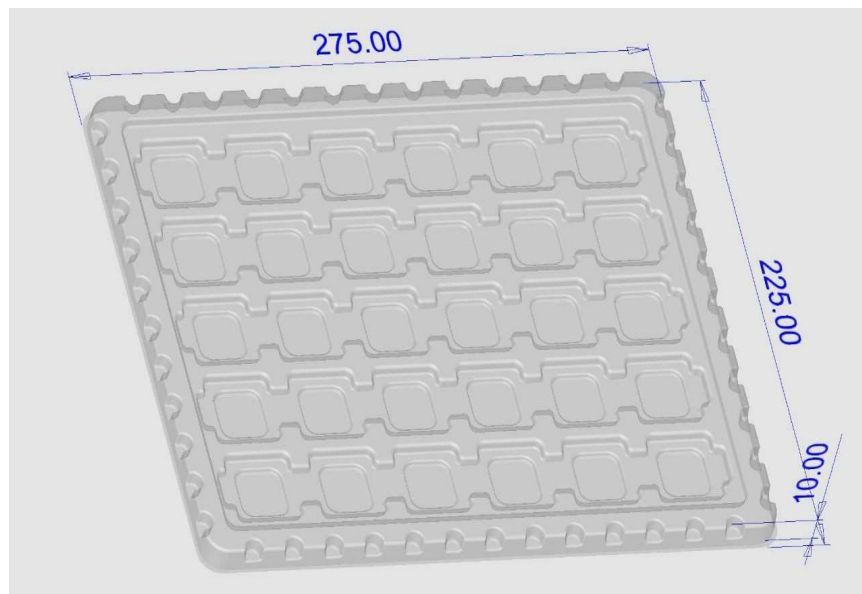

## Precaution

### Handling with care for this product

- Both the light emitting area and white rim around the light emitting area is composed of resin materials. Please avoid the resin area from being pressed, stressed, rubbed, come into contact with sharp metal nail (e.g. edge of reflector part) because the function, performance and reliability of this product are negatively impacted.
- Please be aware that this product should not come into contact with any other parts while incorporating in your lighting apparatus or your other products.
- Please be aware that careful handling is required after the attachment of lead wires to prevent the application of any load to the connections.
- For more information, please refer to application note "Instruction Manual (COB LED Package)".

### Countermeasure against static electricity

- Handling of this product needs countermeasures against static electricity because this is a semiconductor product.
- Please take adequate measures to prevent any static electricity being produced such as the wearing of a wristband or anti-static gloves when handling this product.
- Every manufacturing facility in regard to the product (plant, equipment, machine, carrier machine and conveyance unit) should be connected to ground and please avoid the product to be electric-charged.
- ESD sensitivity of this product is over 1000V (HBM, based on JEITA ED-4701/304). After assembling the LEDs into your final product(s), it is recommended to check whether the assembled LEDs are damaged by static electricity (electrical leak phenomenon) or not.
- It is easy to find static damaged LED dies by a light-on test with the minimum current value.

### Caution of product assembly

- Regarding this product assembling on the heat sink, it is recommended to use M4 screw. It might be good for screw tightening on the heat sink to do temporary tightening and final tightening. In addition, please don't press with excess stress on the product.
- The condition of the product assembling on the heat sink and the control of screw tightening torque needs to be optimized according to the specification of the heat sink.
- Roughness, unevenness and burr of surface negatively impact thermal bonding between the product and heat sink and increase heat thermal resistance between them. Confidence of thermally and mechanical coupling between the product and heat sink are confirmed by checking the mounting surface and measuring the case temperature of the product.
- In order to reduce the thermal resistance at assembly, it might be good to use TIM (Thermal Interface Material) on whole contact surface of the product. In case of using thermal grease for the TIM, it might be good to apply uniformly on the contact surface of the product.
- In case of using thermal sheet for the TIM, it might be good to make sure that the product is NOT strained by stress when the screws are tightened for assembly.
- For more information, please refer to application note "Instruction Manual (COB LED Package)".

## Thermal Design

-The thermal design to draw heat away from the LED junction is most critical parameter for an LED illumination system. High operating temperatures at the LED junction adversely affect the performance of LED's light output and lifetime. Therefore, the LED junction temperature should not exceed the absolute maximum rating in LED illumination system.

-The LED junction temperature while operation of LED illumination system depends upon thermal resistance of internal LED package (R<sub>j-c</sub>), outer thermal resistances of LED package, power loss and ambient temperature. Please take both of the thermal design specifications and ambient temperature conditions into consideration for the setting of driving conditions.

-For more information, please refer to application note "Thermal Management", "Instruction Manual (COB LED Package)".

## Driving Current

-A constant current is recommended as an applying driving current to this product.

In the case of constant voltage driving, please connect current-limiting resistor to each product in series and control the driving current to keep under the absolute maximum rating forward current value.

-Electrical transient might apply excess voltage, excess current and reverse voltage to the product(s). They also affect negative impact on the product(s) therefore please make sure that no excess voltage, no excess current and no reverse voltage are applied to the product(s) when the LED driver is turn-on and/or turn-off.

-For more information, please refer to application note "Driving", "Instruction Manual (COB LED Package)".

## Lighting at a minimum current value

-A minimum current value of lighting of all dice is 5 mA.

-When a minimum current is applied, LED dice may look different in their brightness due to the individual difference of the LED element, and it is not a failed product.

## Electrical Safety

-This product is designed and produced according to IEC 62031:2008 IEC 62031:2008 LED modules for general lighting. Safety specification)

-Dielectric voltage withstand test has been conducted on this product to see any failure after applying voltage between active pads and aluminum section of the product, and to pass at least 500V.

-Considering conformity assessment for IEC62031:2008, almost all items of the specification depend upon your final product of LED illumination system. Therefore, please confirm with your final product for electrical safety of your product. As well, the products comply with the criteria of IEC62031:2008 as single LED package.

## **Recommended soldering Condition (This product is not adaptable to reflow process.)**

-For manual soldering Please use lead-free soldering. Soldering shall be implemented using a soldering bit at a temperature lower than 350C, and shall be finished within 3.5 seconds for one land. No external force shall be applied to resin part while soldering is implemented. Next process of soldering should be carried out after the product has return to ambient temperature. Contacts number of soldering bit should be within twice for each terminal.

\* Polymatech Electronics cannot guarantee if usage exceeds these recommended conditions. Please use it after sufficient verification is carried out on your own risk if absolutely necessary.

- For more information, please refer to application note "Instruction Manual (COB LED Package)".

### **Eye Safety**

-The International Electrical Commission (IEC) published in 2006 IEC 62471 "2006 Photobiological safety of lamps and lamp systems" which includes LEDs within its scope. When sorting single LEDs according to IEC 62471, almost all white LEDs can be classified as belonging to either Exempt Group (no hazard) or Risk Group 1 (low risk). However, Optical characteristics of LEDs such as radiant flux, spectrum and light distribution are factors that affect the risk group determination of the LED, and especially a high-power LED, that emits light containing blue wavelengths, might have properties equivalent to those of Risk Group 2 (moderate risk).

-Great care should be taken when directly viewing an LED that is driven at high current, has multiple uses as a module or when focusing the light with optical instruments, as these actions might greatly increase the hazard to your eyes. It is recommended to regard the evaluation of stand-alone LED packages as a reference and to evaluate your final product.

### **This product is not designed for usage under the following conditions.**

If the product might be used under the following conditions, you shall evaluate its effect and appropriate them. In places where the product might:

- directly and indirectly get wet due to rain and/or at place with the fear.
- be damage by seawater and/or at place with the fear
- be exposed to corrosive gas (such as Cl<sub>2</sub>, H<sub>2</sub>S, NH<sub>3</sub>, SO<sub>x</sub>, NO<sub>x</sub> and so on) and/or at place with the fear.
- be exposed to dust, fluid or oil and/or at place with the fear.

The LEDs may not be able to maintain their specified performance if they used in a high temperature and high humidity environment.

## Precaution with regard to product use

This document is provided for reference purposes only so that POLYMATECH ELECTRONICS products are used as intended. POLYMATECH ELECTRONICS neither makes warranties or representations with respect to the accuracy or completeness of the information contained in this document nor grants any license to any intellectual property rights or any other rights of POLYMATECH ELECTRONICS or any third party with respect to the information in this document. Before purchasing or using any POLYMATECH ELECTRONICS products listed in this document, please confirm the latest product information with a POLYMATECH ELECTRONICS sales office, and formal specifications must be exchanged and signed by both parties prior to mass production.

All information included in this document such as product data, diagrams, charts, is current as of the date this document is issued.

Such information, however, is subject to change without any prior notice.

POLYMATECH ELECTRONICS has used reasonable care in compiling the information included in this document, but POLYMATECH ELECTRONICS assumes no liability whatsoever for any damages incurred as a result of errors or omissions in the information included in this document.

Absent a written signed agreement, except as provided in the relevant

terms and conditions of sale for product, and to the maximum extent allowable by law, POLYMATECH ELECTRONICS assumes no liability whatsoever, including without limitation, indirect, consequential, special, or incidental damages or loss, including without limitation, loss of profits, loss of opportunities, business interruption and loss of data, and disclaims any and all express or implied warranties and conditions related to sale, use of product, or information, including warranties or conditions of merchantability, fitness for a particular purpose, accuracy of information, or no infringement.

Though POLYMATECH ELECTRONICS works continually to improve products' quality and reliability, products can malfunction or fail. Customers are responsible for complying with safety standards and for providing adequate designs and safeguards to minimize risk and avoid situations in which a malfunction or failure of a product could cause loss of human life, bodily injury or damage to property, including data loss or corruption. In addition, customers are also responsible for determining the appropriateness of use of any information contained in this document such as application cases not only with evaluating by their own but also by the entire system. POLYMATECH ELECTRONICS assumes no liability for customers' product design or applications.

The LEDs described in this brochure are intended to be used for ordinary electronic equipment (such as office equipment, communications equipment, measurement instruments and household appliances). Consult POLYMATECH Electronics' sales staff in advance for information on the applications in which exceptional quality and reliability are required, particularly when the failure or malfunction of the LEDs may directly jeopardize life or health (such as for airplane, aerospace, submersible repeaters, nuclear reactor control system, automobiles, traffic control equipment, life support system and safety devices). This LED does not comply with ISO/TS 16949 (IATF16949) and is not intended for automotive applications.

The customer shall not reserve engineer by disassembling or analysis of the LEDs without having prior written consent from POLYMATECH Electronics. When defective

LEDs are found, the customer shall inform Polymatech Electronics before disassembling or analysis.

When exporting our products, please ensure conformance with applicable laws and regulations and take appropriate actions such as obtaining an export license. Please do not use or supply our products for any weapons of mass destruction (WMD) or for any other military purposes. If we do not receive standing orders, we may recommend another product. If this product is to be used for a different model or for a succeeding model continuously, please contact our sales staff.

Please contact POLYMATECH ELECTRONICS' sales office if you have any questions regarding the information contained in this document, or if you have any other inquiries.